



ScanFix[®]

Une Solution Modulaire sur Mesure



ScanFix®

Une Solution Modulaire sur Mesure

La gamme ScanFix® offre des possibilités infinies pour créer des espaces architecturaux intérieurs personnalisés et en conformité avec les réglementations européennes.

Elle est constituée de panneaux de particules de 19 mm, revêtues des deux côtés d'une pellicule stratifiée de 0,7mm haute densité résistant à l'eau et peuvent être ignifugés suivant les options.

La conception de la gamme ScanFix® est basée sur la Norme ISO3394 permettant l'utilisation de Tiroirs Jointifs, Bacs, Paniers aux

dimensions 600*400mm de Grande (B) ou de Petite (A) façade à hauteur variable.

ScanFix® est conçu pour répondre à des besoins spécifiques et sur mesure aussi bien pour vos paillasse humides et de préparations (Volkern ou Synthétique type Corian).

Vous pouvez la configurer avec différentes hauteurs et types de fermetures, Porte, Volet Roulant ou Tiroirs Télescopiques vous permettant de répondre à l'ensemble de vos besoins d'ergonomie dans vos espaces de soins.



ScanFix[®]

Une Solution Modulaire sur Mesure

Les poignées en Aluminium Anodisé de 110mm permettent une codification des Armoires.



Les charnières permettent une ouverture à 220°. Elles sont intégrées évitant tout accrochage avec des éléments passant à proximité.

Les portes sont munies de profilés d'angles arrondis en Aluminium Extrudé. Ces profilés permettent une résistance importante face aux chocs traditionnellement rencontrés avec les Chariots ou Lits d'hôpitaux.

Les socles de nos éléments fixes sont dotés de vis réglables en hauteur permettant un ajustement de chaque élément. Le socle est recouvert **d'une plinthe PVC étanche** permettant d'assurer une hygiène parfaite des locaux.



ScanFix[®]

Une Solution Modulaire sur Mesure

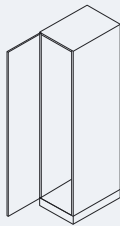

Porte, Grande et Petite Façade..

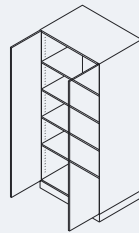

Double Porte 900 ou 1 300mm de façade.

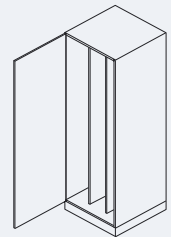

Porte, Grande et Petite Façade avec support endoscope coulissant.

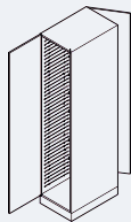

Armoire de transfert avec portes, Grande et Petite Façade.

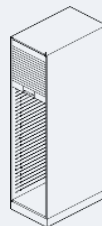

Volet Roulant, Grande et Petite Façade..

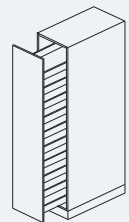

Façade coulissante

Typologie
Armoire Haute
1 200 à 2 100 mm de Hauteur



ScanFix[®]

Une Solution Modulaire sur Mesure

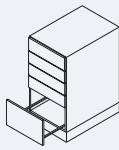

Tiroir Télescopique, Grande et Petite Façade. Composition sur demande.

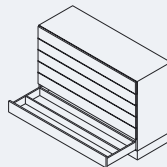

Tiroir Télescopique 900 et 1 300 mm de longueur pour cathéter.

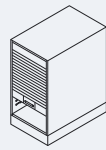

Volet Roulant, Grande et Petite Façade..

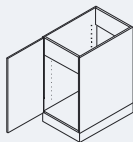

Porte, Grande et Petite Façade.

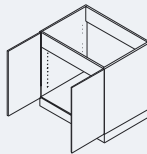

Sous Évier, Double Porte 900 ou 1 300mm de façade.

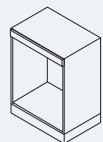

Armoire inférieur pour frigo.

Typologie
Armoire Inférieur
900mm de Hauteur



ScanFix[®]

Une Solution Modulaire sur Mesure

Nuancier
de Couleurs

Karshmir		Beaujolais		Café		Iris		Carnaval		Capri	
Chrome Yellow		Fox		Bermuda		Blase Red		Clémentine		Levante	
Monaco		Wasabi		Amarena		Spectrum Blue		Ocean Grey		Folkstone	
Mojave		Choco		Denim		Oladel					

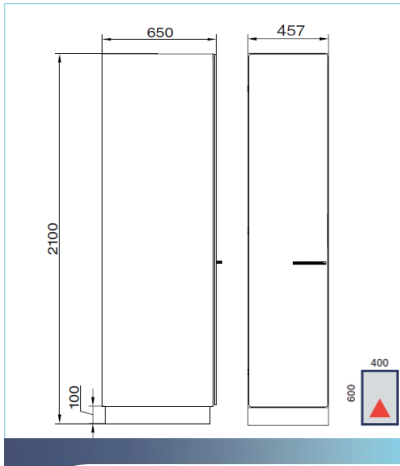

Armoires Hautes 2 100 • Type A

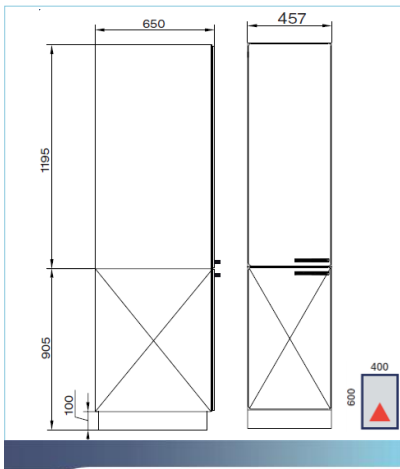
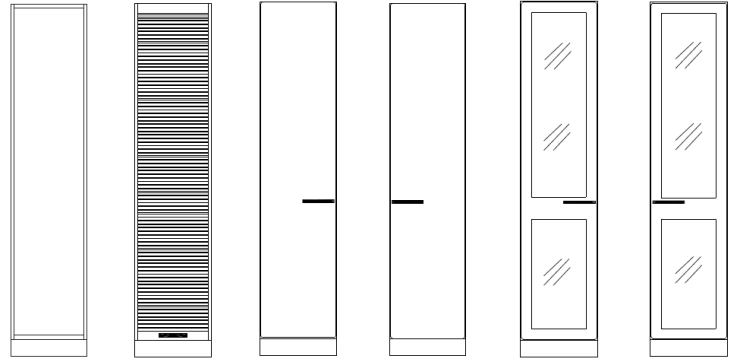

Armoires Supérieures 1 195 • Type A

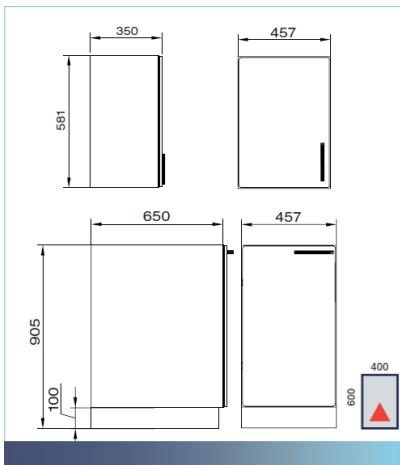
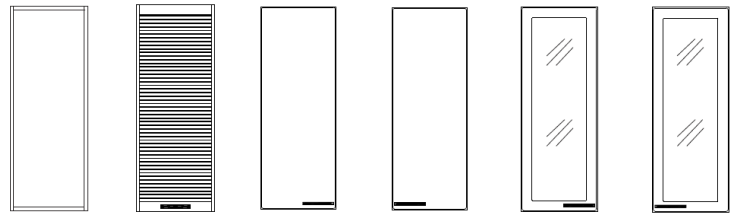

Armoires Supérieures et Inférieures • Type A et D

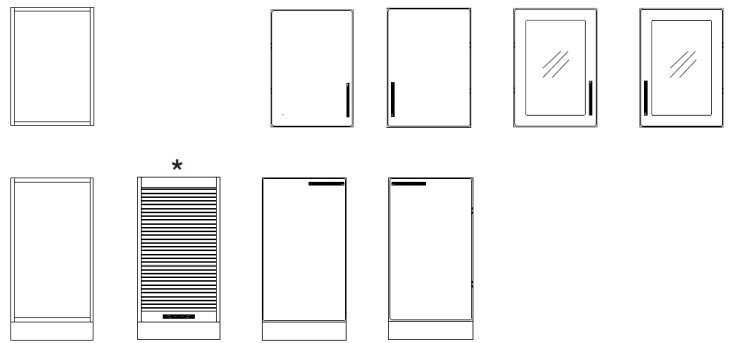

Armoires Basses ▪ Tiroirs Télescopiques ▪ Type A

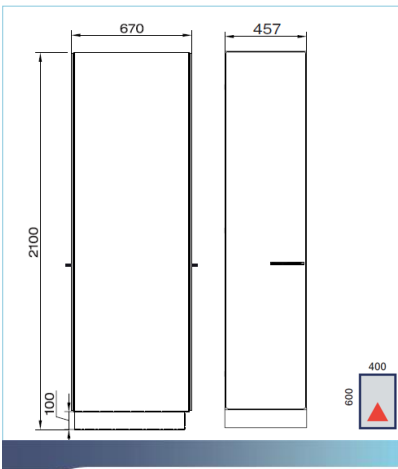
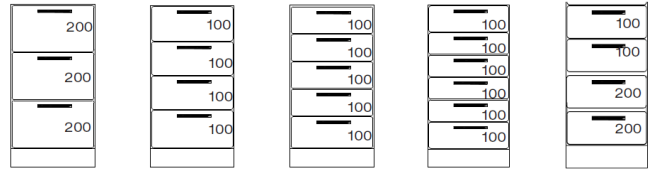
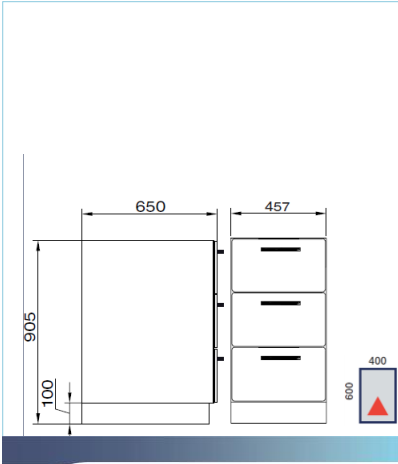

Armoires de Transmission ▪ Type A

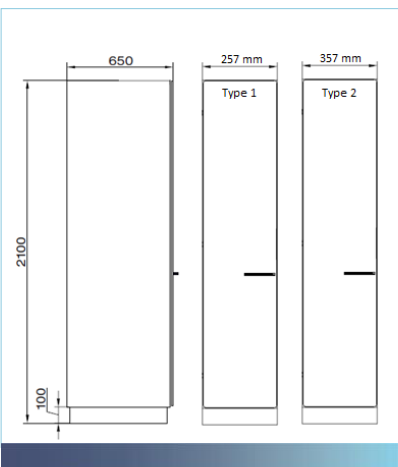
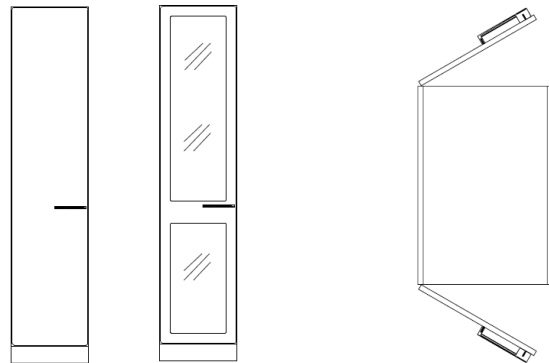

Armoires Coulissantes

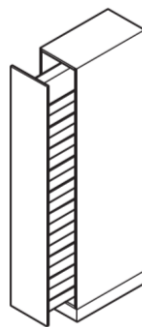

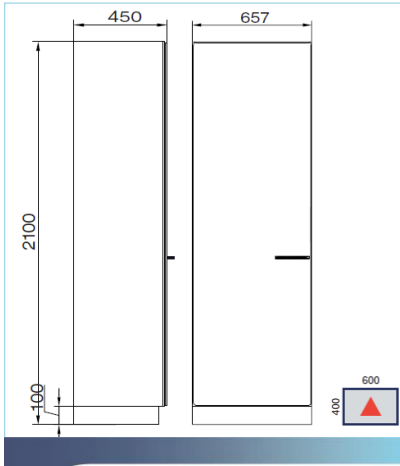

Armoires Hautes 2 100 • Type B

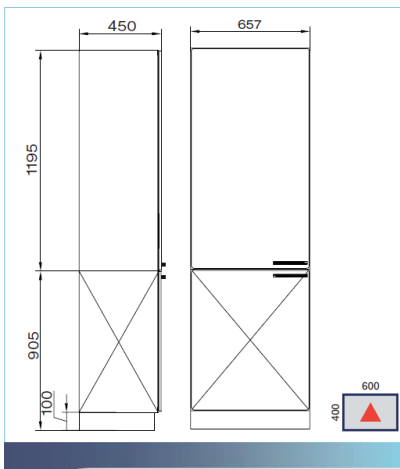
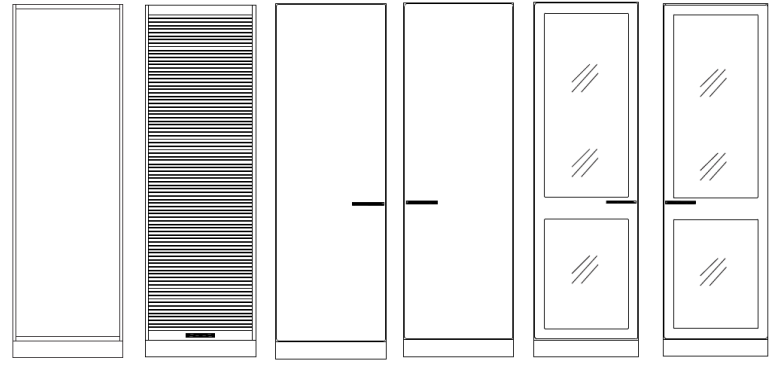

Armoires Supérieures 1 195 • Type B

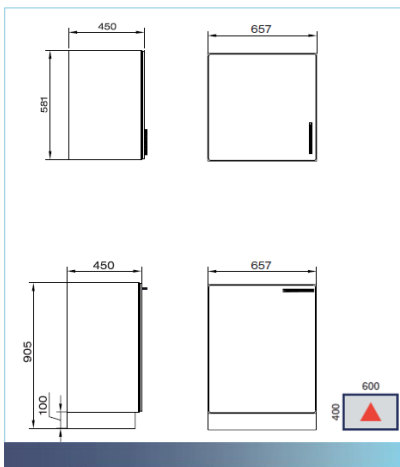
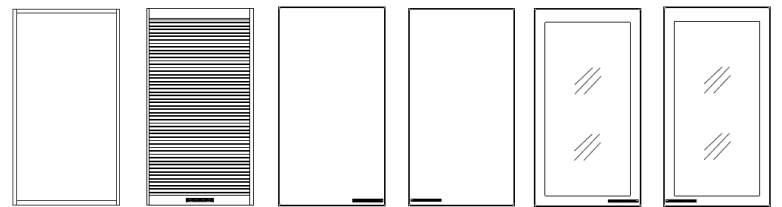

Armoires Supérieures et Inférieures • Type B

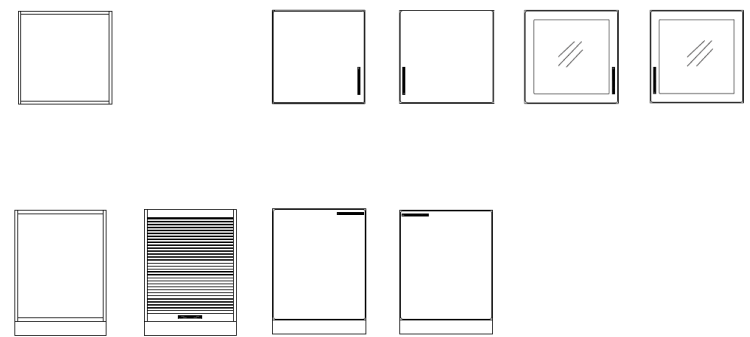

Armoires Basses ▪ Tiroirs Télescopiques ▪ Type B

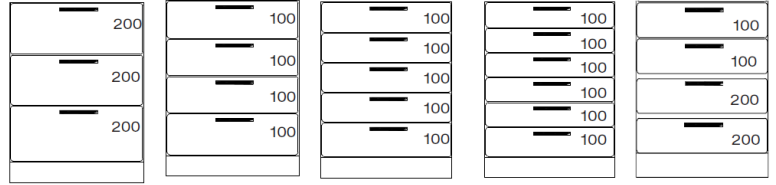
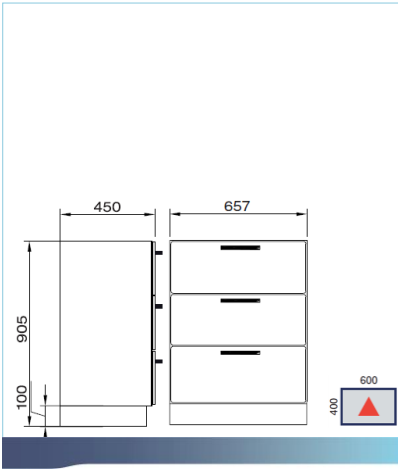

Armoires de Transmission ▪ Type B

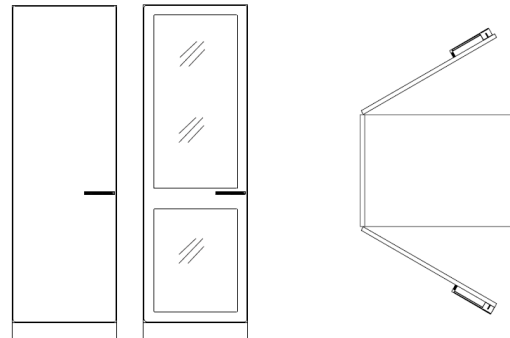
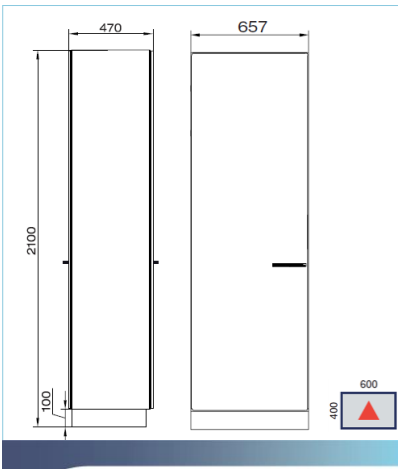

Paillasse

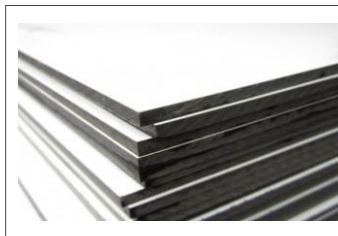

Article Référence	Qté	Dimensions	Type
Sur Demande	-	Résine – Type Corian	
Sur Demande	-	Volkern Blanc	

Dimensions sur demande

Evier et Lave-Mains pour Paillasse Humide



Article Référence	Qté	Dimensions	Type
06KAW04S28	1	400 * 400 * 300 mm	
06KAW06S28	1	550 * 400 * 300 mm	

Autres Dimensions sur demande

Robinetterie - Mitigeur



Article Référence	Qté	Dimensions	Type
2564T4	1	H. 300 * L. 250 mm	
2210	1	H. 145 * L. 220 mm	
20164T4	1	Electronique H. 305 * 250 mm	

Autres configurations sur demande

Pied Chromé et Equerre Murale pour Paillasse



Article Référence	Qté	Dimensions	Type
429211473	1	Pied Chromé – H. 710 mm	-
429206490	1	Pied Chromé – H. 900 mm	-
0715002	1	Equerre Murale	-

Autres Dimensions sur demande